

Article number: 206153M20KNMVK

Description: E+G stainless steel spring plungers 615.3-M20-KN-MVK

Measures

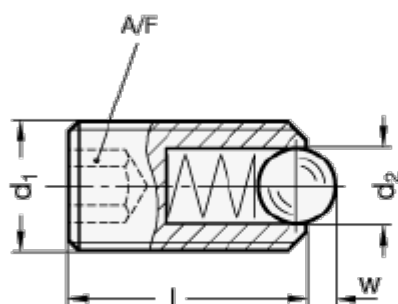

Thread locking **PFB**
Polyamide patch
for type **KN**



Thread locking **PFB**
Polyamide patch
for type **KSN**



Thread locking **MVK**
Micro encapsulation precote
(for all types)

A/F	= 10
d1	= M20
d2	= 12
l	= 43
Max. spring load in N	= 111
Preload spring pressure in N	= 56
w	= 4.5